



# CorePro LED PLC 4P



## CorePro LED PLC 9W 840 4P G24q-3

De Philips CorePro LED PLC 4P is een LED-lichtbron in de vorm van een traditionele fluorescentielamp. Dit product vormt de ideale oplossing voor het opwaarderen van TL-verlichting in algemene verlichtingstoepassingen: het voldoet aan de basiseisen voor verlichting, biedt aanzienlijke energiebesparingen en is milieuvriendelijk.

### Product gegevens

Algemene informatie	
Lampvoet	G24Q-3 [G24q-3]
Nominale levensduur	30.000 hr
Schakelcyclus	50.000
Lighting Technology	LED
Meetreferentie van lichtstroom	Sphere

Eisen aan armatuurontwerp	
Kleurcode	840 [CCT of 4000K]
Bundelhoek (nom.)	120 graden
Lichtstroom	1.000 lm
Kleuraanduiding	Koelwit (CW)
Gecorreleerde kleurtemperatuur (nom)	4000 K
Lichtrendement (nominaal)	100,00 lm/W
Kleurconsistentie	<6
Kleurweergave-index (CRI)	83
LLMF bij einde nominale levensduur (nom.)	70 %

Bedrijfs- en elektrische gegevens	
Line Frequency	30000-80000 Hz
Ingangsfrequentie	30000-80000 Hz
Energieverbruik	9 W
Opstarttijd (nom.)	0,5 s

Opwarmtijd tot 60% licht	0.5 s
Vermogensfactor (fractie)	0.9
Spanning (nom.)	20-50 V

Temperatuur	
T-behuizing maximaal (nom.)	76 °C

Regelsystemen en dimmers	
Dimbaar	Nee

Mechanische eigenschappen en behuizing	
Productlengte	200 mm
Lampvorm	Buis, enkelkneeps

Goedkeuring en toepassing	
Energie-efficiëntielabel	F
Energiebesparend product	Ja
Keurmerken	TUV CE-markering RoHS-conform KEMA-KEUR-certificaat
Energieverbruik kWh/1.000 uur	9 kWh
EPREL-registratienummer	403.551
CE-markering	Ja

# CorePro LED PLC 4P

EU RoHS-conform	Ja
<b>Productgegevens</b>	
Full EOC	871869654117300
Productnaam voor bestelling	CorePro LED PLC 9W 840 4P G24q-3
Bestelcode	54117300
Lokale code	CPLC9W840Q3

Numerator - Aantal per pak	1
Numerator - Dozen per buitendoos	10
Materiaalnummer (12NC)	929001200902
Volledige productnaam	CorePro LED PLC 9W 840 4P G24q-3
EAN/UPC - Case	8718696541180

## Maatschets

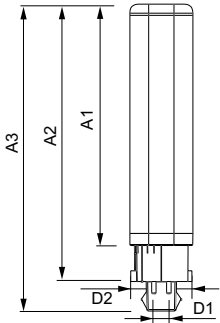

Product	D1	D2	A1	A2	A3
CorePro LED PLC 9W 840 4P G24q-3	24,3 mm	28,4 mm	128,8 mm	148 mm	163,6 mm

## Fotometrische gegevens

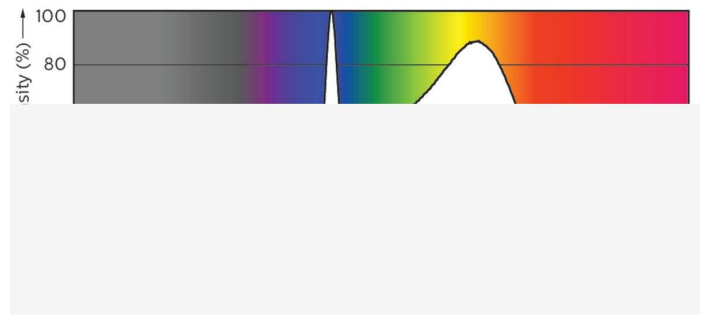
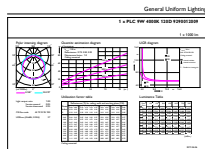

Spectral Power Distribution Colour - CorePro LED PLC 9W 840 4P G24q-3

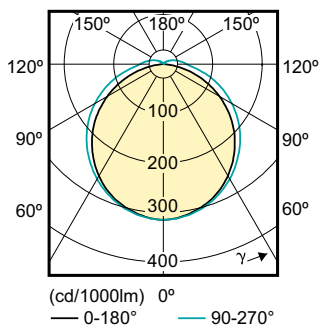

Light Distribution Diagram - CorePro LED PLC 9W 840 4P G24q-3

# CorePro LED PLC 4P

## Levensduur

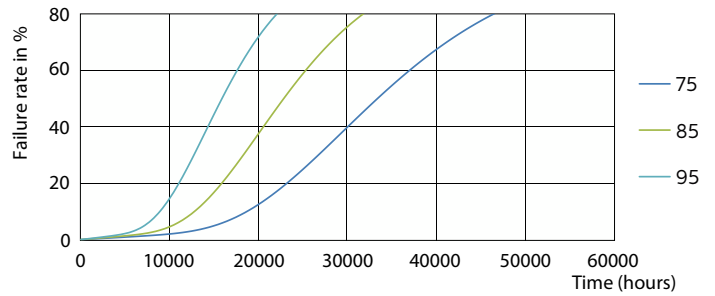
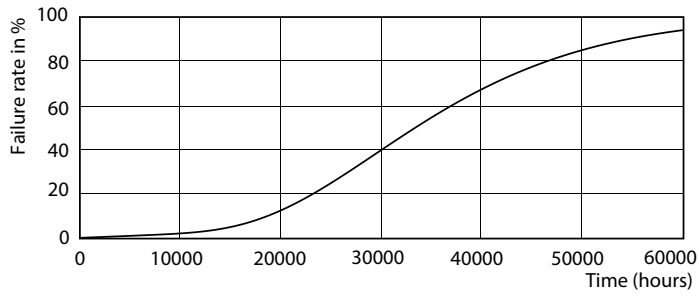

Life Expectancy Diagram - CorePro LED PLC 9W 840 4P G24q-3

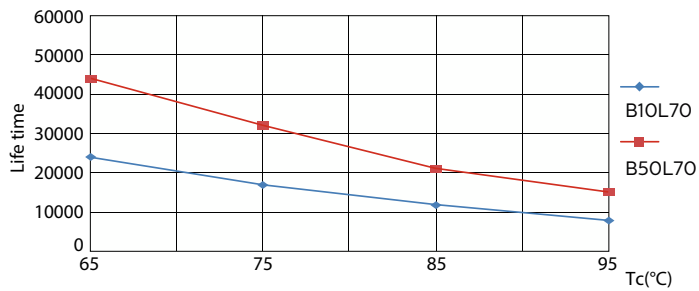

Life Expectancy Diagram - CorePro LED PLC 9W 840 4P G24q-3

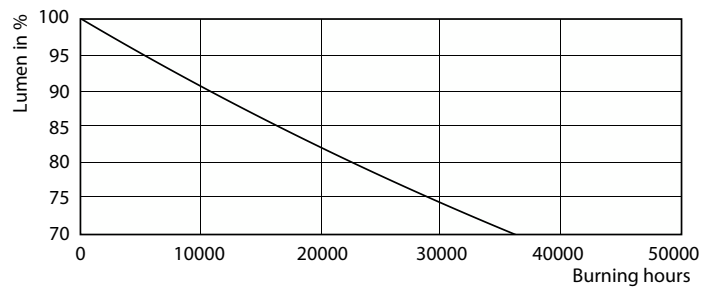

Life Expectancy Diagram - CorePro LED PLC 9W 840 4P G24q-3

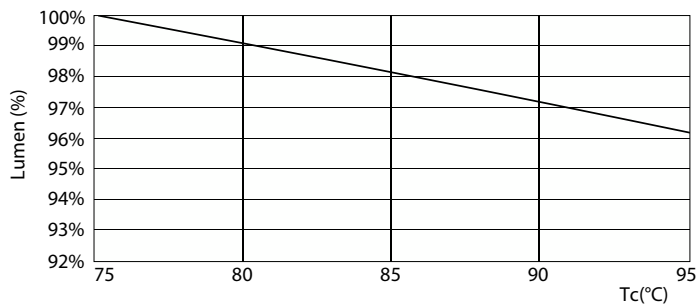

Lumen Maintenance Diagram - CorePro LED PLC 9W 840 4P G24q-3

Lumen Maintenance Diagram - CorePro LED PLC 9W 840 4P G24q-3

## CorePro LED PLC 4P

