



# CorePro LED PLC 4P

## CorePro LED PLC 6.5W 840 4P G24q-2

De Philips CorePro LED PLC 4P is een LED-lichtbron in de vorm van een traditionele fluorescentielamp. Dit product vormt de ideale oplossing voor het opwaarderen van TL-verlichting in algemene verlichtingstoepassingen: het voldoet aan de basiseisen voor verlichting, biedt aanzienlijke energiebesparingen en is milieuvriendelijk.

### Product gegevens

Algemene informatie			
Lampvoet	G24Q-2 [G24q-2]	Opwarmtijd tot 60% licht	0.5 s
Nominale levensduur	30.000 hr	Vermogensfactor (fractie)	0.9
Schakelcyclus	50.000	Spanning (nom.)	20-50 V
Lighting Technology	LED	<b>Temperatuur</b>	
Meetreferentie van lichtstroom	Sphere	T-behuizing maximaal (nom.)	66 °C
<b>Eisen aan armatuurontwerp</b>		<b>Regelsystemen en dimmers</b>	
Kleurcode	840 [CCT of 4000K]	Dimbaar	Nee
Bundelhoek (nom.)	120 graden	<b>Mechanische eigenschappen en behuizing</b>	
Lichtstroom	700 lm	Productlengte	100 mm
Kleuraanduiding	Koelwit (CW)	Lampvorm	Buis, enkelkneeps
Gecorreleerde kleurtemperatuur (nom)	4000 K	<b>Goedkeuring en toepassing</b>	
Lichtrendement (nominiaal)	92,31 lm/W	Energiebesparend product	Ja
Kleurconsistentie	<6	Keurmerken	TUV CE-markering RoHS-conform KEMA-KEUR-certificaat
Kleurweergave-index (CRI)	83	Energieverbruik kWh/1.000 uur	7 kWh
LLMF bij einde nominale levensduur (nom.)	70 %	EPREL-registratienummer	403.553
<b>Bedrijfs- en elektrische gegevens</b>		CE-markering	Ja
Line Frequency	30000-80000 Hz	EU RoHS-conform	Ja
Ingangsfrequentie	30000-80000 Hz		
Energieverbruik	6,5 W		
Opstarttijd (nom.)	0,5 s		

# CorePro LED PLC 4P

## Productgegevens

Full EOC	871869654121000
Productnaam voor bestelling	CorePro LED PLC 6.5W 840 4P G24q-2
Bestelcode	54121000
Lokale code	CPLC6.5W840Q2
Numerator - Aantal per pak	1

Numerator - Dozen per buitendoos	10
Materiaalnummer (12NC)	929001201102
Volledige productnaam	CorePro LED PLC 6.5W 840 4P G24q-2
EAN/UPC - Case	8718696541227

## Maatschets

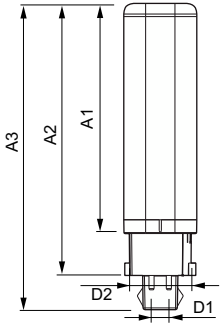

Product	D1	D2	A1	A2	A3
CorePro LED PLC 6.5W 840 4P G24q-2	24,3 mm	28,4 mm	105,8 mm	125 mm	140,6 mm

## Fotometrische gegevens

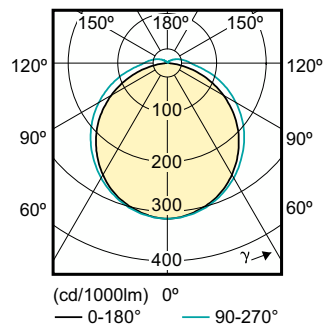
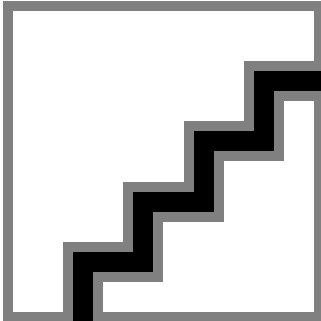

## Spectral Power Distribution Colour - CorePro LED PLC 6.5W 840 4P G24q-2

## Light Distribution Diagram - CorePro LED PLC 6.5W 840 4P G24q-2

# CorePro LED PLC 4P

## Levensduur

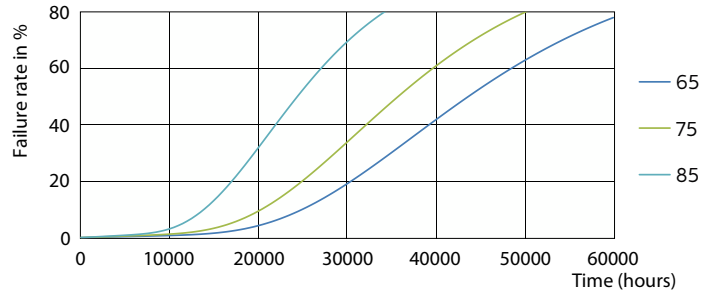
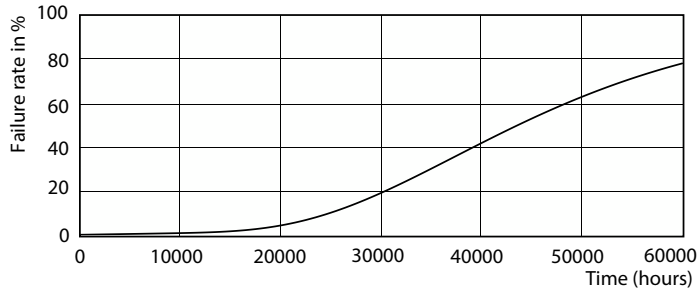

Life Expectancy Diagram - CorePro LED PLC 6.5W 840 4P G24q-2

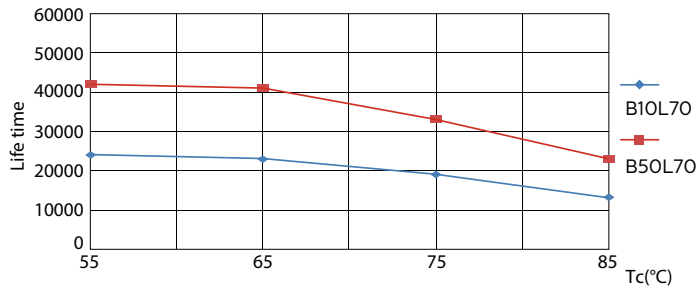

Life Expectancy Diagram - CorePro LED PLC 6.5W 840 4P G24q-2

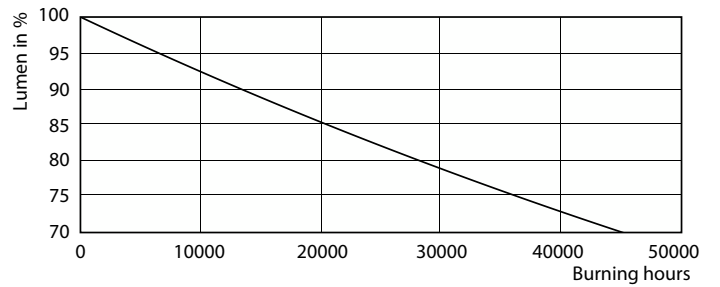

Life Expectancy Diagram - CorePro LED PLC 6.5W 840 4P G24q-2

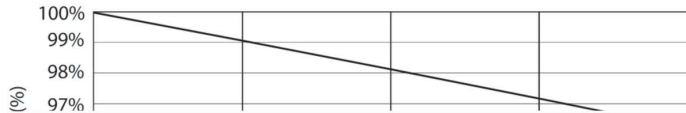

Lumen Maintenance Diagram - CorePro LED PLC 6.5W 840 4P G24q-2

Lumen Maintenance Diagram - CorePro LED PLC 6.5W 840 4P G24q-2

## CorePro LED PLC 4P

